

SMD32254P

Features

A small surface-mount type crystal unit, ideal for OA, AV and Accessories for a car, which need performance for wide temperature range.

- Compact and thin. (3.2×2.5×0.7mm typ.)
- Excellent electrical performance, ideal for OA and AV applications.
- Excellent environmental performance, including heat and shock resistance.
- Meets the requirements for re-flow profiling using lead-free solder.

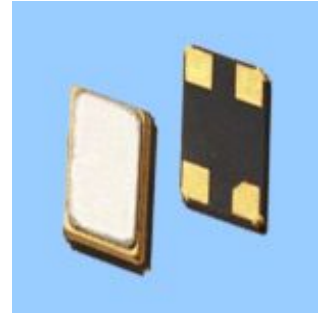

Specifications

项目Item	技术Specifications	备注Remarks
频率范围Freq. Range	13.52127MHz	Fund. ;AT-Cut
调整频差Freq. Tol.	±10PPm [~]	Others are offered 25°C ±3°C
负载电容Load Capacitance	Fund. ;7pF [~]	明确注释please specify
Series Resistance	As ESR table	
Storage Temperature	±10PPm [~]	可依实际而定Others are offered
工作温度Operaing Temp	-20°C to 70°C -40°C to 85°C	可依实际而定Others are offered
储存温度Storage Temp	-55°C to 125°C	
最大值Max, drive level	1000 μW	
建议使用Rec, drive level	100 μW	
静电容 Shunt Capacitance	5pF Max	
绝缘电阻 Insulation Resistance	500m Ω Min	Minimum
老化率Aging	±2PPm/Year Max	Maximum

Dimensions

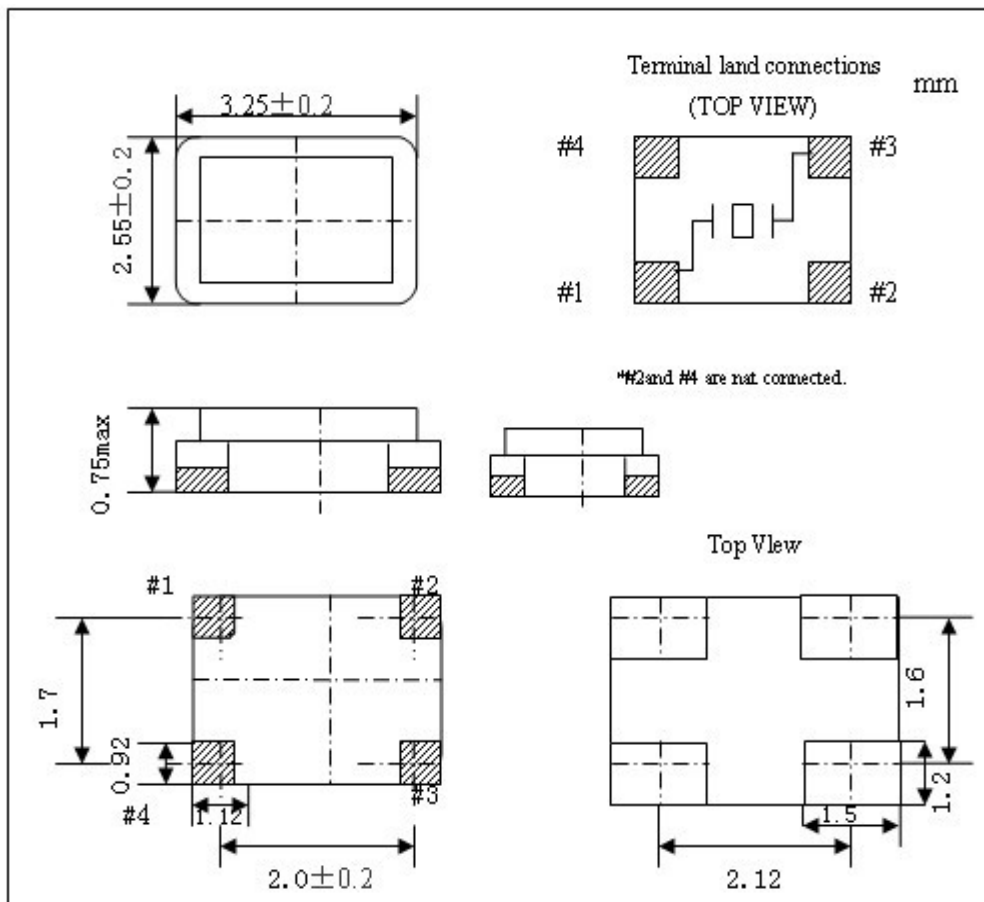

■ Taping Specification

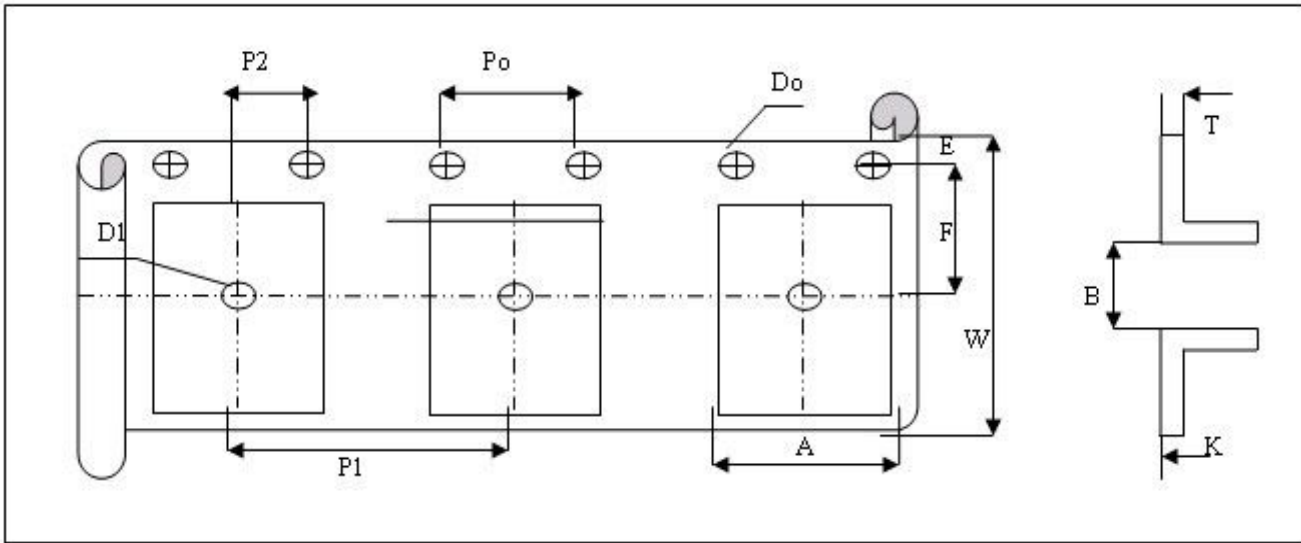

Symbol	A	B	Do	D1	E	F
DIMENSION	3.2*2.5	2.8	3.5	1.5	1	1.75
Symbol	K	Po	P1	P2	T	W
DIMENSION	3.2*2.5	1	4	8	2	0.25

Unit:mm

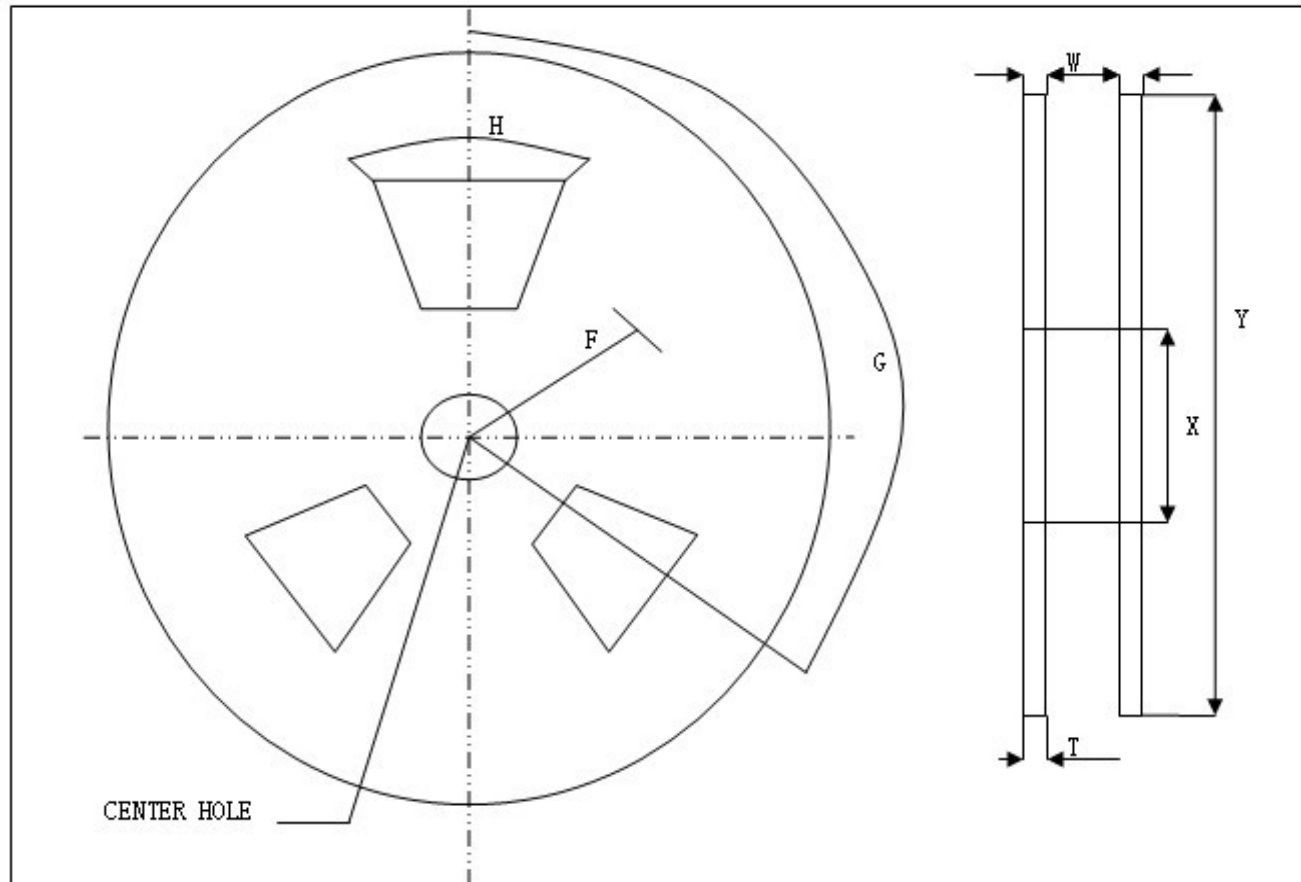

Symbol	H	F	G	W	T	X	Y
Dimension	3.2*2.5	40°	21±0.8	120	17.5	2	50