

SMD5032

■ Features

A small surface-mount type crystal unit, ideal for OA, AV and Accessories for a car, which need performance for wide temperature range.

- Compact and thin. (5×3.2×1.1mm typ.)
- Excellent electrical performance, ideal for OA and AV applications.
- Excellent environmental performance, including heat and shock resistance.
- Meets the requirements for re-flow profiling using lead-free solder.

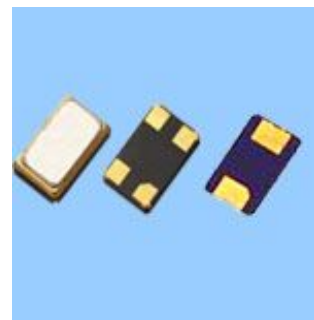

■ Specifications

项目 Item	技术 Specifications
频率范围 Freq. Range	20.000MHz
调整频差 Freq. Tol.	±10PPm to ±100PPm
负载电容 Load Capacitance	Suggested by customer
Series Resistance	As ESR table
Storage Temperature	±10PPm to ±100PPm
工作温度 Operating Temp	-10°C to 60°C to -40°C to 85°C
储存温度 Storage Temp	-40°C to 85°C to -55°C to 125°C
最大值 Max, drive level	1000 μW
激励功率, drive level	100 μW Typical
静电容 Shunt Capacitance	7pF Max
绝缘电阻 Insulation Resistance	500mΩ Min at D.C 100v
老化率 Aging	±5PPm/Year Max

■ ESR (Series Resistance) 等效阻抗和振荡模式

Frequency (MHz)	Mode	Ohm Max	Frequency (MHz)	Mode	Ohm Max
8~10	Fundamental	100	20~24	Fundamental	40
10~12	Fundamental	80	24~50	Fundamental	30
12~16	Fundamental	60	50~150	Third Overtone	80
16~20	Fundamental	50			

■ Ordering Information

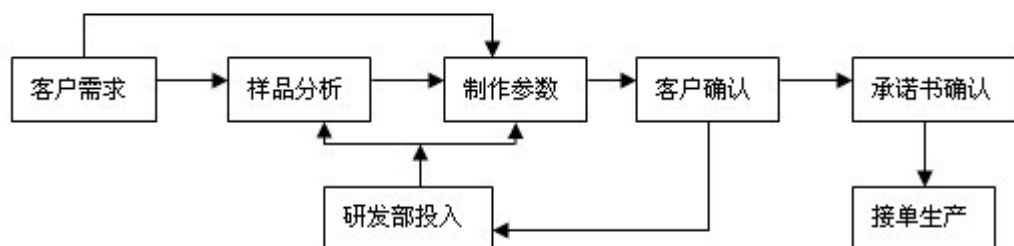

■ Dimensions

■ Reflow Condition

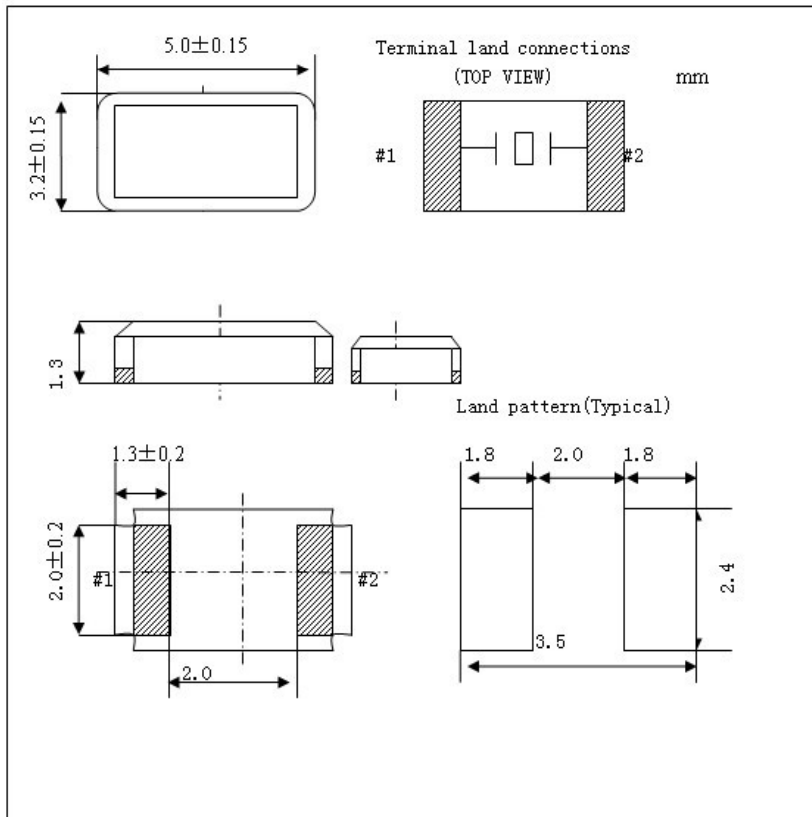
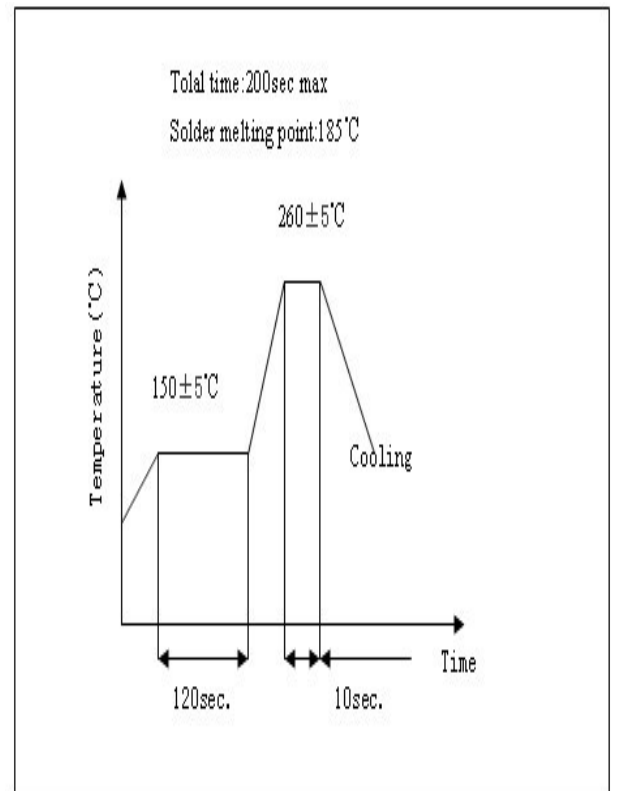
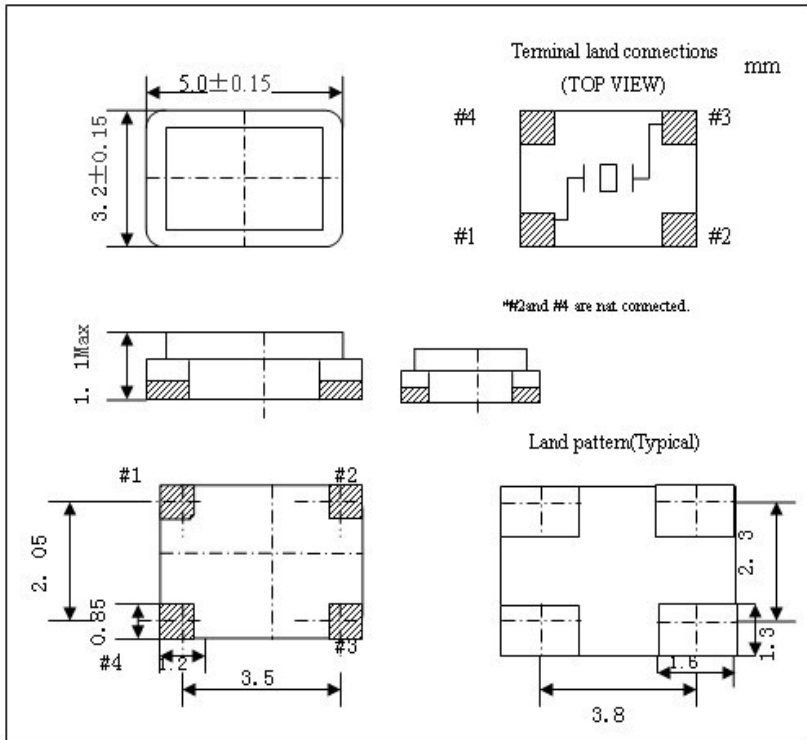

■ Taping Specification

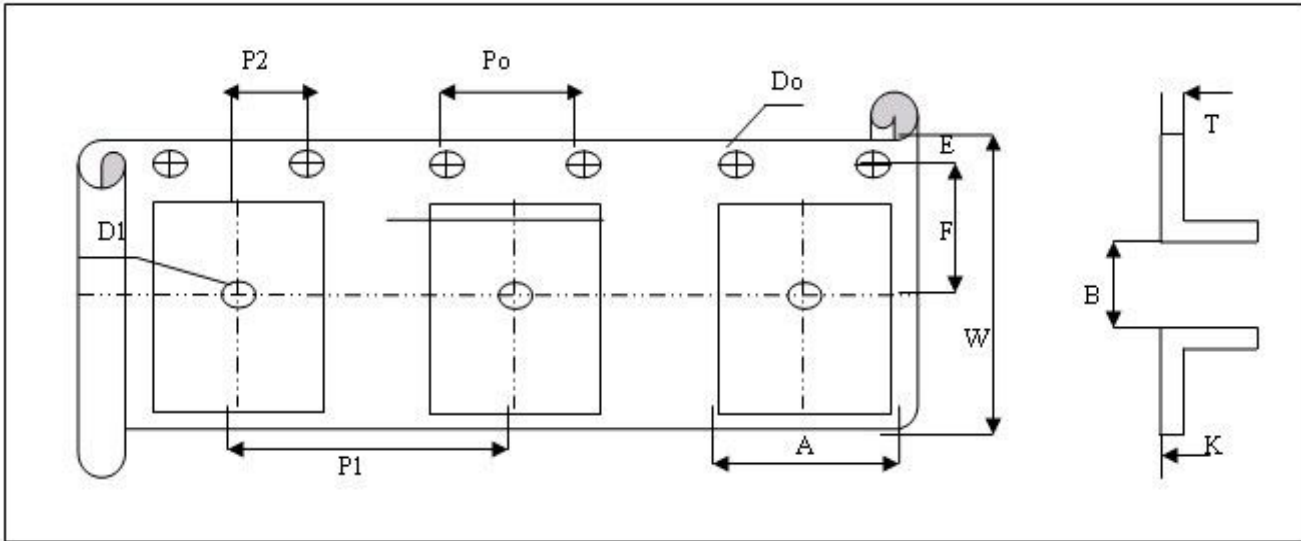

Symbol	A	B	Do	D1	E	F
DIMENSION	5*3.24P	3.5	1.5	1.5	1.75	5.5
Symbol	K	Po	P1	P2	T	W
DIMENSION	5*3.24p	1.1	8	2	0.25	12

Unit:mm

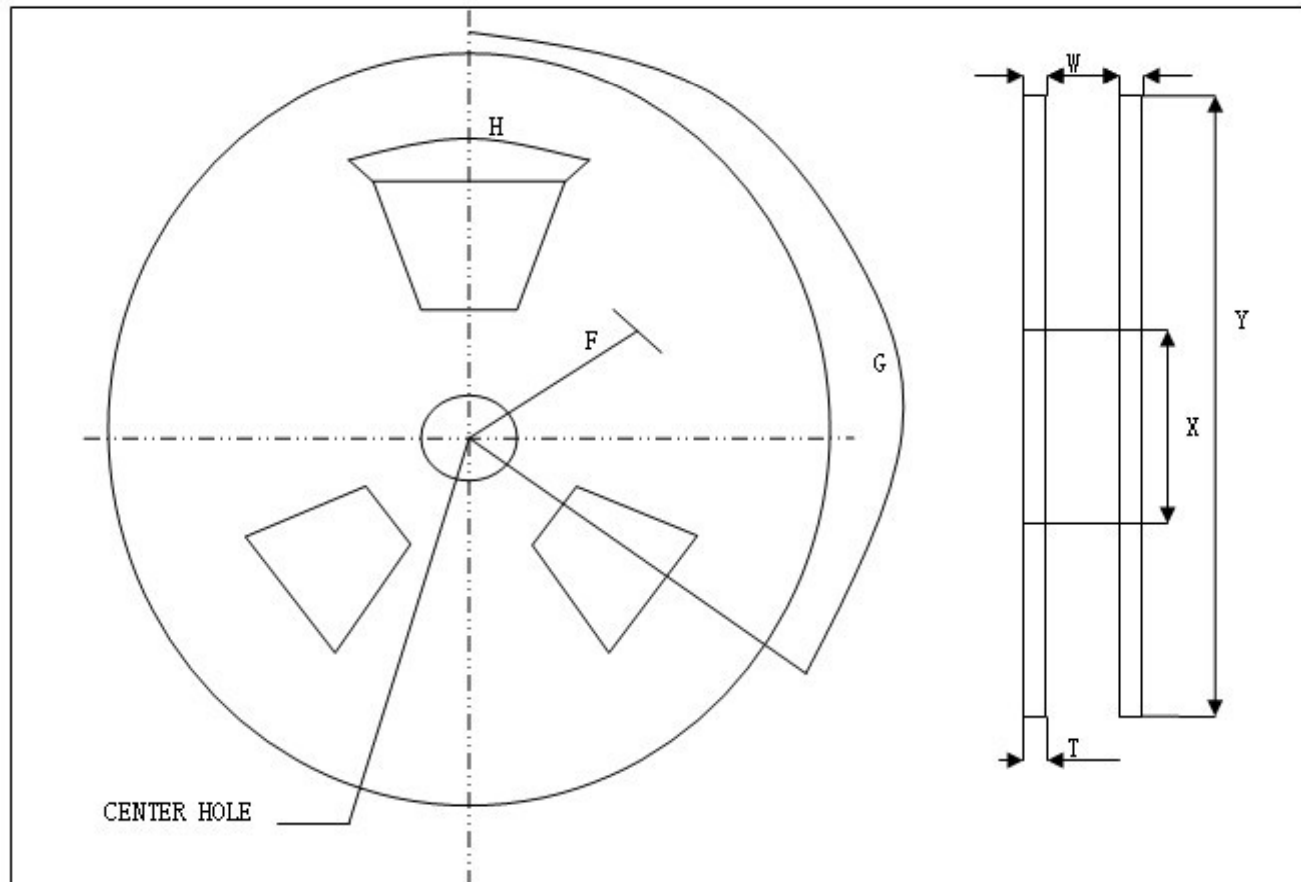

Symbol	H	F	G	W	T	X	Y
Dimension	5*3.24P	40°	21±0.8	120	17.5	50	250