

钟振DIP14-11.2896MHZ

Features

- voltage(1.8V~5.0V)
- Output Waveform(cmos)
- Supports a WIDE FREQUENCY RANGE(20K to 800MHZ)
- Output Voltage:0.4~2.4VDC
- Compact with dimensions of 20.3×12.5×7.0mm



Specifications

| 项目Item | 技术Specifications | |
|--------------------------|---|-------------|
| 输出波形 Output Waveform | 方波 (cmos) | |
| 频率范围Freq. Range | 11.2896MHZ | |
| 频率稳定性Frequency Stability | ±10PPm, ±20PPm, ±30PPm, ±50PPm | |
| 工作温度Operaing Temp | -20°C to 70°C (-40°C to 85°C available) | |
| 储存温度Storage Temp | -55°C to 125°C | |
| 输出波形对称性 Output Symmetry | 40-60%@1.4VDC (45-55% available) | |
| 电压Input Voltage:VDD | +5.0Vdc ±5% or +3.3Vdc ±5% available | |
| 电流Input Current:IDD | 100KHz to 70MHz, ≤20mA | |
| | 70MHz to 200MHz, ≤40mA | |
| | ≥200.00MHz, ≤60mA | |
| 上升时间Rise Time | TR | ≤6ns |
| 下降时间Fall Time | TF | ≤6ns |
| 输出电压Output Voltage | VOL | 0.4Vdc Max. |
| | VOH | 2.4Vdc Min. |
| 输出负载Output Load | 10LSTTL | |
| 起动时间Start up Time | <10ms | |
| 老化能力 Agek Resistance | ±3PPm Max | |

Ordering Information



输出波形图



Dimensions



管脚功能

- 1: VC/NC
- 7: GND
- 8: OUT
- 14: VCC (+5.0 VDC)

测试电路图

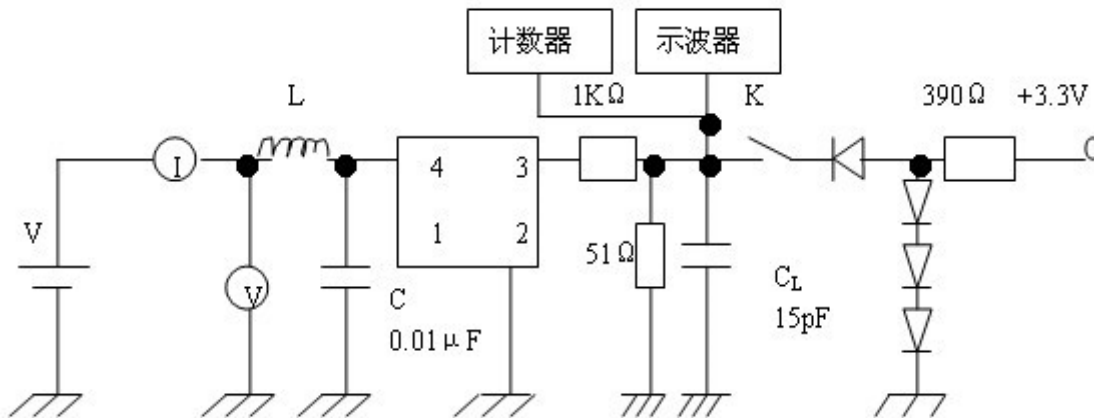

使用电路图和引出端功能说明

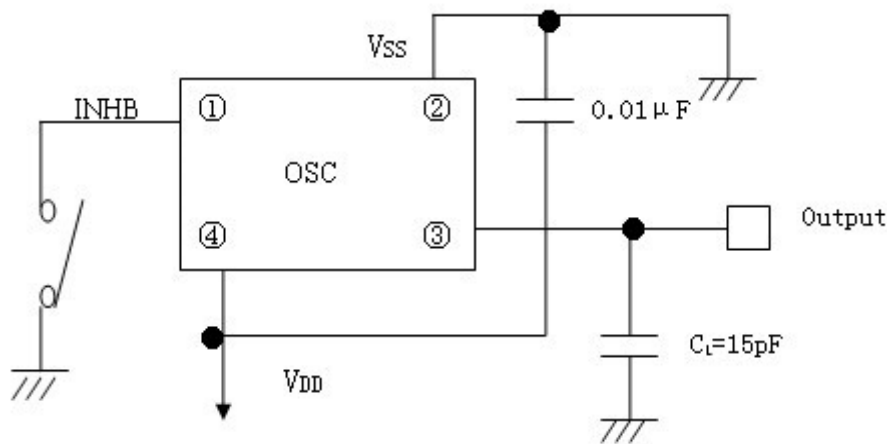

| | | |
|-----------------------------------|---------------|------------|
| 引脚 | 1 | 2 |
| 功能 | 输出状态控制/NC | 地VSS |
| 引脚 | 3 | 4 |
| 功能 | 输出QOUT | 电源VDD |
| 输出控制端 INHB | “H”高电平或开路OPEN | “L”低电平(三态) |
| 输出Qout | 振荡器正常输出 | 高阻抗 |
| 注意：输出状态控制端INHB（三态端）不能接地，否则振荡器呈高阻抗 | | |