

温补晶体振荡器TCXO-77.76MHZ

Features

- voltage (3.3V~5.0V)
- Output Waveform (CMOS/TTL)
- Supports a WIDE FREQUENCY RANGE 77.76MHZ
- Versus Temperature Range: 1.0ppm~2.5ppm
- Compact with dimensions of 20.8×13.5×8mm
12.8*12.8*7mm



Specifications

项目Item	技术Specifications			备注Remarks	
频率范围	77.76MHZ			Fundamental AT-Cut PPL	
工作温度	-10℃ to 60℃	-40℃ to 85℃			
频率温度特性	±0.5PPM	±1.5PPM			
电源电压	5.0Vdc ±5% or 3.3Vdc ±5%				
电源电流	5mA Max			Clippde Sine	
	20mA Max			TTL/CMOS	
老化率	±1.0PPM			per Year	
频率稳定性	±0.2PPM			Vcc ±5% (25℃)	
Jitter (抖动)	3ps			RMS Noise	
Allan Variance	3PPB				
Phase Noise (相位噪声)	100Hz	-100dBc/Hz			
	1KHz	-130dBc/Hz			
	10KHz	-140dBc/Hz			
	100KHz	-145dBc/Hz			
输出, 负载特点	A	Output Waveform	TTL	CMOS	Clippde Sine
	B	Output Levels	TTL	CMOS	1V pkTO pk
	C	Duty Cycle	50% ±10%	50% ±10%	-
	D	Rise/Fall Time	5ns	5ns	-
	E	Load	10TTL	15pF	10K Ω //10pF
Frequency Adjustment	±1PPM Min				

Dimensions

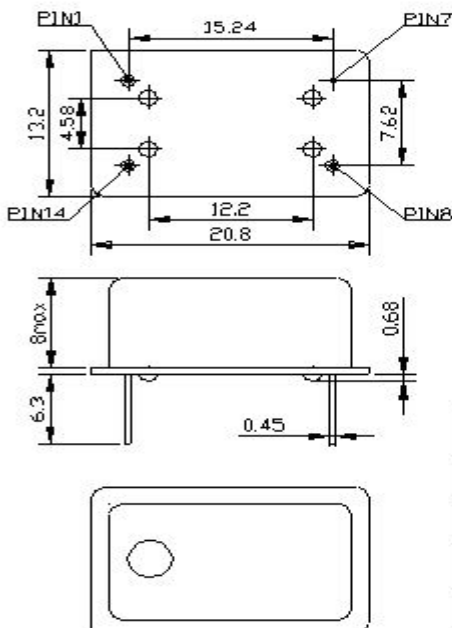

PIN	FUNCTION
1	Vcon/NC
7	GND
8	Output
14	Power Supply