

## OSC3225-5.000MHZ

### Features

- Tight frequency tolerance.
- CMOS compatible logic levels.
- Pin-compatible with standard 3.2\*2.5\*1.2mm. packages
- Low power standby mode.
- Designed for standard reflow and washing techniques.
- Available on tape & reel, 1000pcs per reel.
- Pb-free and RoHS/Green compliant.



### APPLICATIONS

- Ideally suited designed for use in Ethernet, network adapter cards, hard disk devices, blue tooth PCMCIA Cards, Palmtop Computer, Portable Applications.

### Specifications 电气参数

项目Item	技术Specifications
频率范围Freq. Range	5.000MHZ
总频差Frequency Stability	$\pm 20\text{ppm}$ TO $\pm 50\text{ppm}$
工作温度Operaing Temp	$-10^{\circ}\text{C}$ to $60^{\circ}\text{C}$ / $-40^{\circ}\text{C}$ to $85^{\circ}\text{C}$
储存温度Storage Temp	$-40^{\circ}\text{C}$ to $85^{\circ}\text{C}$ / $-55^{\circ}\text{C}$ to $125^{\circ}\text{C}$
输入电压Supply Voltage	+5Vdc or 3.3V $\pm 10\%$ ※(see Notes)
占空比 Symmetry	40/60 Standard
输出Output Load	10 TTL or 15PF HCMOS
消耗电流	Current Consumption 15pf only) (5.0V)
	1.000mhz-49.999mhz =25mA max
	50.000mhz-125.000mhz =80mA max
	Current Consumption 15pf only) (1.8V 2.5V 2.85V 3.3V)
1.000mhz-49.999mhz =20mA max	
50.000mhz-125.000mhz =60mA max	
上升/下降时间Rise/Fall Time	5nS max

※Notes: The supply voltage 1.8V, 2.5V, 2.85V also can be made by customer.

### Test Circuit 测试电路图

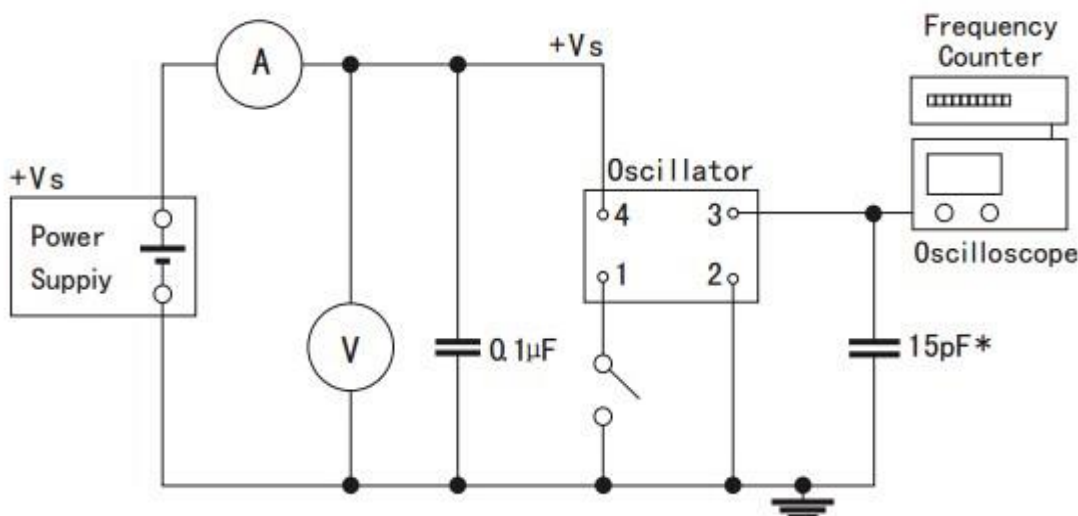

Tri-state: PIN 1 connected to Vdd or floating, the product is working properly; connected to GND, stops working



Dimensions 尺寸封装图

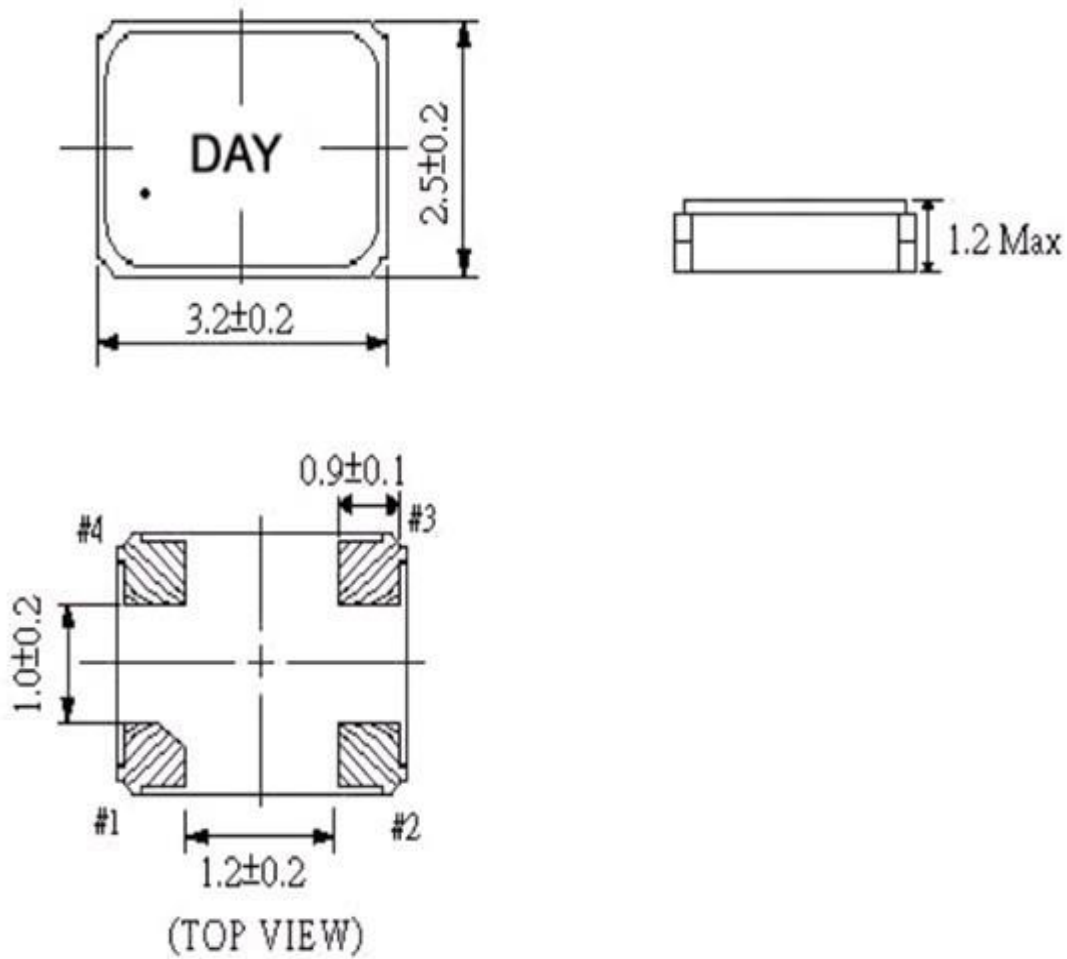

输出波形图

