

OSC3225-33.000MHZ

Features

- Tight frequency tolerance.
- CMOS compatible logic levels.
- Pin-compatible with standard 3.2*2.5*1.2mm. packages
- Low power standby mode.
- Designed for standard reflow and washing techniques.
- Available on tape & reel, 1000pcs per reel.
- Pb-free and RoHS/Green compliant.



APPLICATIONS

- Ideally suited designed for use in Ethernet, network adapter cards, hard disk devices, blue tooth PCMCIA Cards, Palmtop Computer, Portable Applications.

Specifications 电气参数

项目Item	技术Specifications
频率范围Freq. Range	33.000MHZ
总频差Frequency Stability	±20ppm TO ±50ppm
工作温度Operaing Temp	-10°C to 60°C / -40°C to 85°C
储存温度Storage Temp	-40°C to 85°C / -55°C to 125°C
输入电压Supply Voltage	+5Vdc or 3.3V ±10% ※(see Notes)
占空比 Symmetry	40/60 Standard
输出Output Load	10 TTL or 15PF HCMOS
消耗电流	Current Consumption 15pf only) (5.0V)
	1.000mhz-49.999mhz =25mA max
	50.000mhz-125.000mhz =80mA max
	Current Consumption 15pf only) (1.8V 2.5V 2.85V 3.3V)
1.000mhz-49.999mhz =20mA max	
50.000mhz-125.000mhz =60mA max	
上升/下降时间Rise/Fall Time	5nS max

※Notes: The supply voltage 1.8V, 2.5V, 2.85V also can be made by customer.

Test Circuit 测试电路图

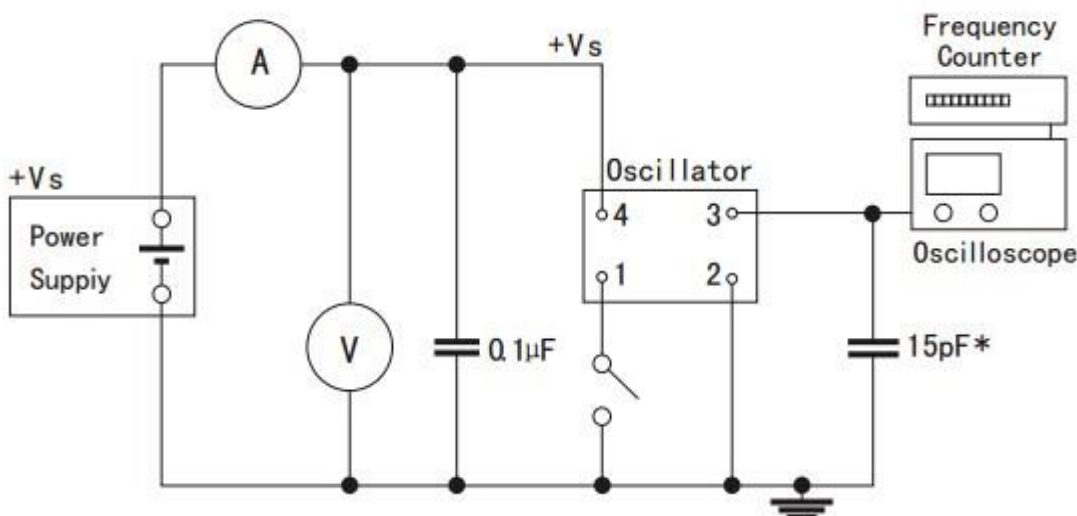

Tri-state: PIN 1 connected to Vdd or floating, the product is working properly; connected to GND, stops working



Dimensions 尺寸封装图

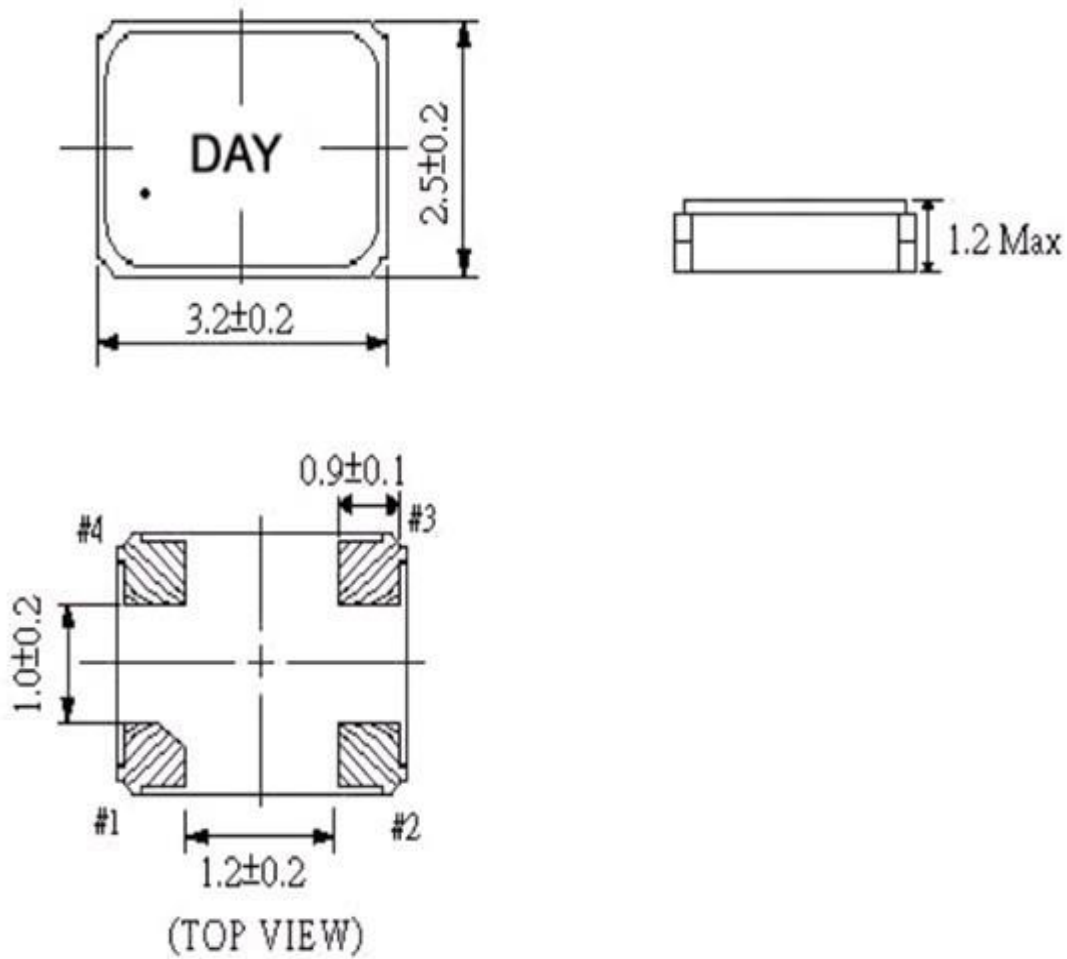

输出波形图

