

OSC5032 9.216MHZ

■ Features

- Tight frequency tolerance.
- Pin-compatible with standard 5.0*3.2*1.3mm. packages
- Low power standby mode.
- surface mounting and automatically loaded.
- Lower noise and current with reduced power consumption.
- Pb-free and RoHS/Green compliant.



■ APPLICATIONS

- Ideally suited designed for use in Ethernet, fiber channel, PCs, NB, CMCIA Cards, Palmtop Computer, Portable Applications.

■ Specifications 电气参数

项目Item	技术Specifications
频率范围Freq. Range	9.216MHZ
总频差Frequency Stability	±20ppm T0 ±50ppm
工作温度Operaing Temp	-20℃ to 70℃ / -40℃ to 85℃
储存温度Storage Temp	-40℃ to 85℃ / -55℃ to 125℃
输入电压Supply Voltage	+5Vdc or 3.3V ±10% ※(see Notes)
占空比 Symmetry	40/60 Standard
输出Output Load	10 TTL or 15PF HCMOS
消耗电流	Current Consumption 15pf only) (5.0V)
	1.000mhz-35.999mhz =25mA max
	36.000mhz-69.999mhz =60mA max
	70.000mhz-100.000mhz =80mA max
	Current Consumption 15pf only) (1.8V 2.5V 2.85V 3.3V)
	1.000mhz-35.999mhz =20mA max
36.000mhz-69.999mhz =40mA max	
70.000mhz-125.000mhz =60mA max	
上升/下降时间Rise/Fall Time	5nS max

※Notes: The supply voltage 1.8V, 2.5V, 2.85V also can be made by customer.

■ Test Circuit 测试电路图

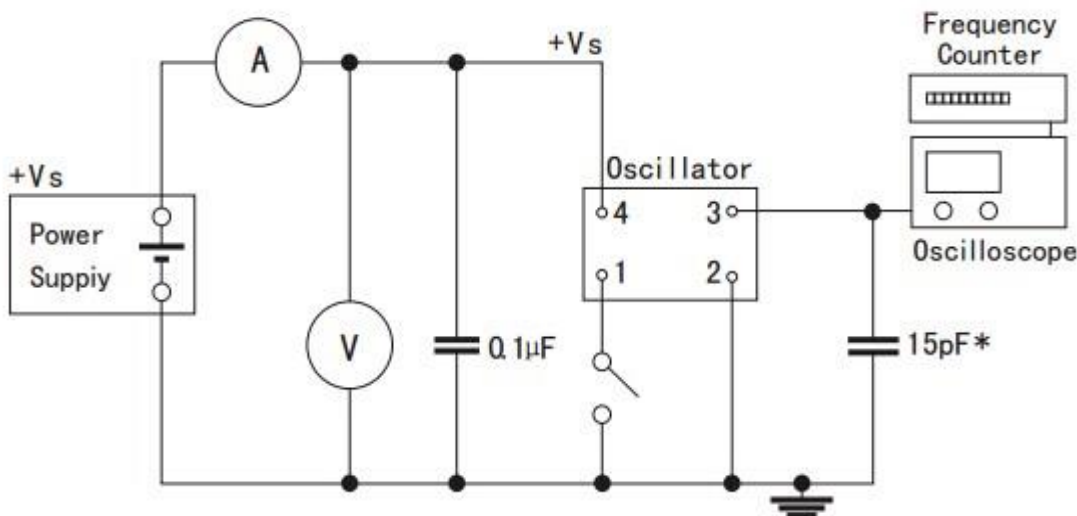

Tri-state: PIN 1 connected to Vdd or floating, the product is working properly; connected to



Dimensions 尺寸封装图

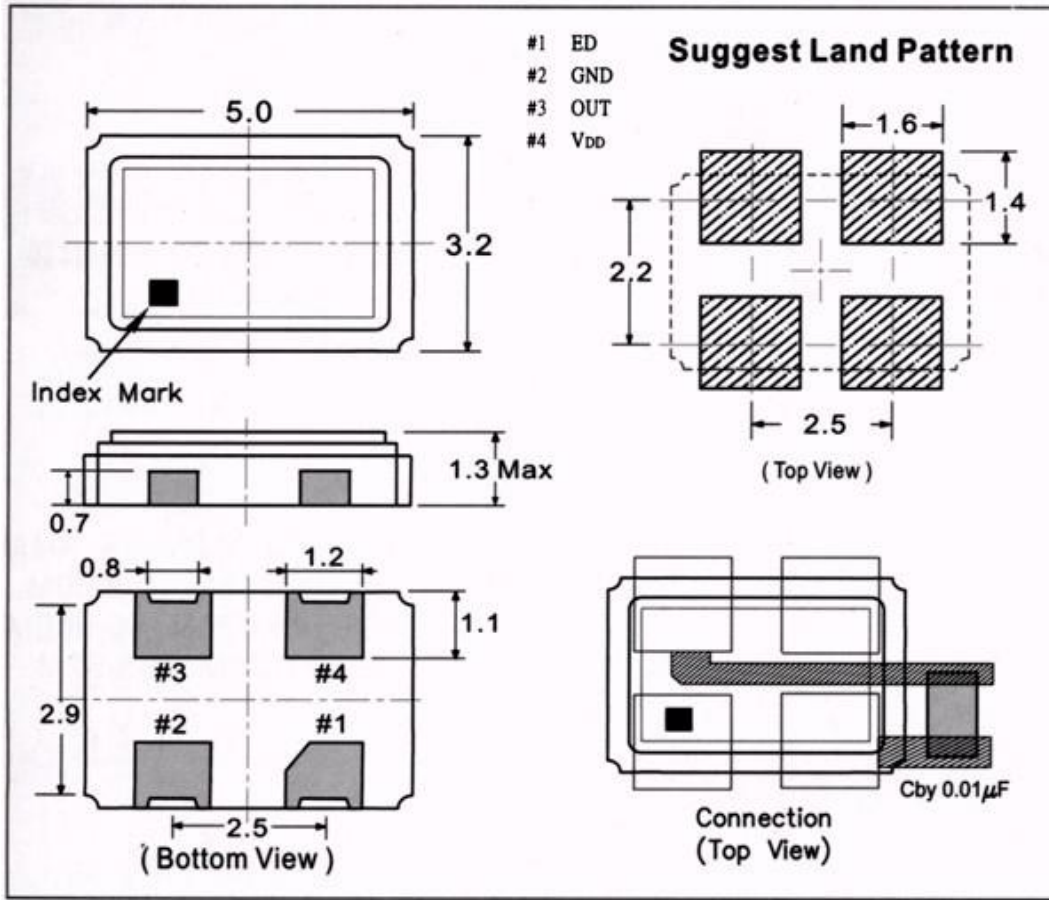

输出波形图

