

OSC7050 24.576MHZ

Features

- CMOS compatible logic levels.
- Pin-compatible with standard 7.0*5*1.4mm. packages
- Low power standby mode.
- High precision characteristic covering up to high frequency range.
- Low jitter and tight stability with fundamental or overtone Design.
- Pb-free and RoHS/Green compliant.
- Output Tri-state function.
- Embossed taping specification.
- Reflow soldering.

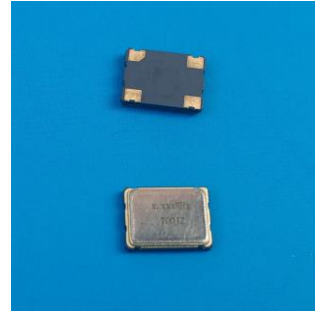

APPLICATIONS

● Ideally suited designed for discdrives ,NB, Networking, GPS/Navigation, BlusTooth, Ethernet, ADSL, VDSL, Fiber channel hand-held electronic products.

Specifications 电气参数

项目Item	技术Specifications
频率范围Freq. Range	24.576MHZ
总频差Frequency Stability	$\pm 20\text{ppm T0} \pm 50\text{ppm}$
工作温度Operaing Temp	$-20^{\circ}\text{C to } 70^{\circ}\text{C} / -40^{\circ}\text{C to } 85^{\circ}\text{C}$
储存温度Storage Temp	$-40^{\circ}\text{C to } 85^{\circ}\text{C} / -55^{\circ}\text{C to } 125^{\circ}\text{C}$
输入电压Supply Voltage	+5Vdc or 3.3V $\pm 10\%$ ※(see Notes)
占空比 Symmetry	40/60 Standard
输出Output Load	15PF HCMOS
消耗电流	Current Consumption 15pf only) (5.0V)
	Current Consumption 15pf only) (1.8V 2.5V 2.85V 3.3V)
上升/下降时间Rise/Fall Time	5nS max

※Notes: The supply voltage 1.8V, 2.5V, 2.85V also can be made by customer.

Test Circuit 测试电路图

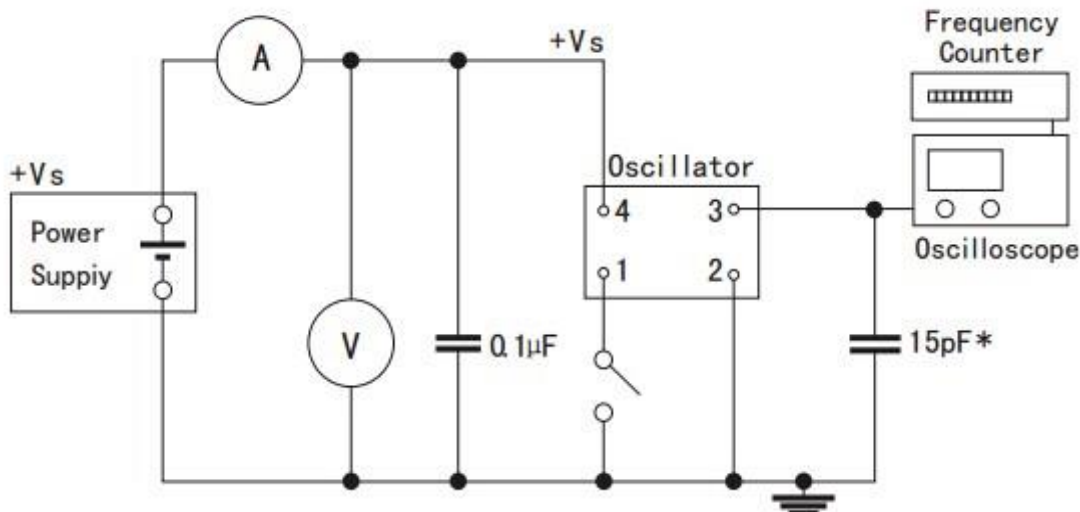

■ Dimensions 尺寸封装图

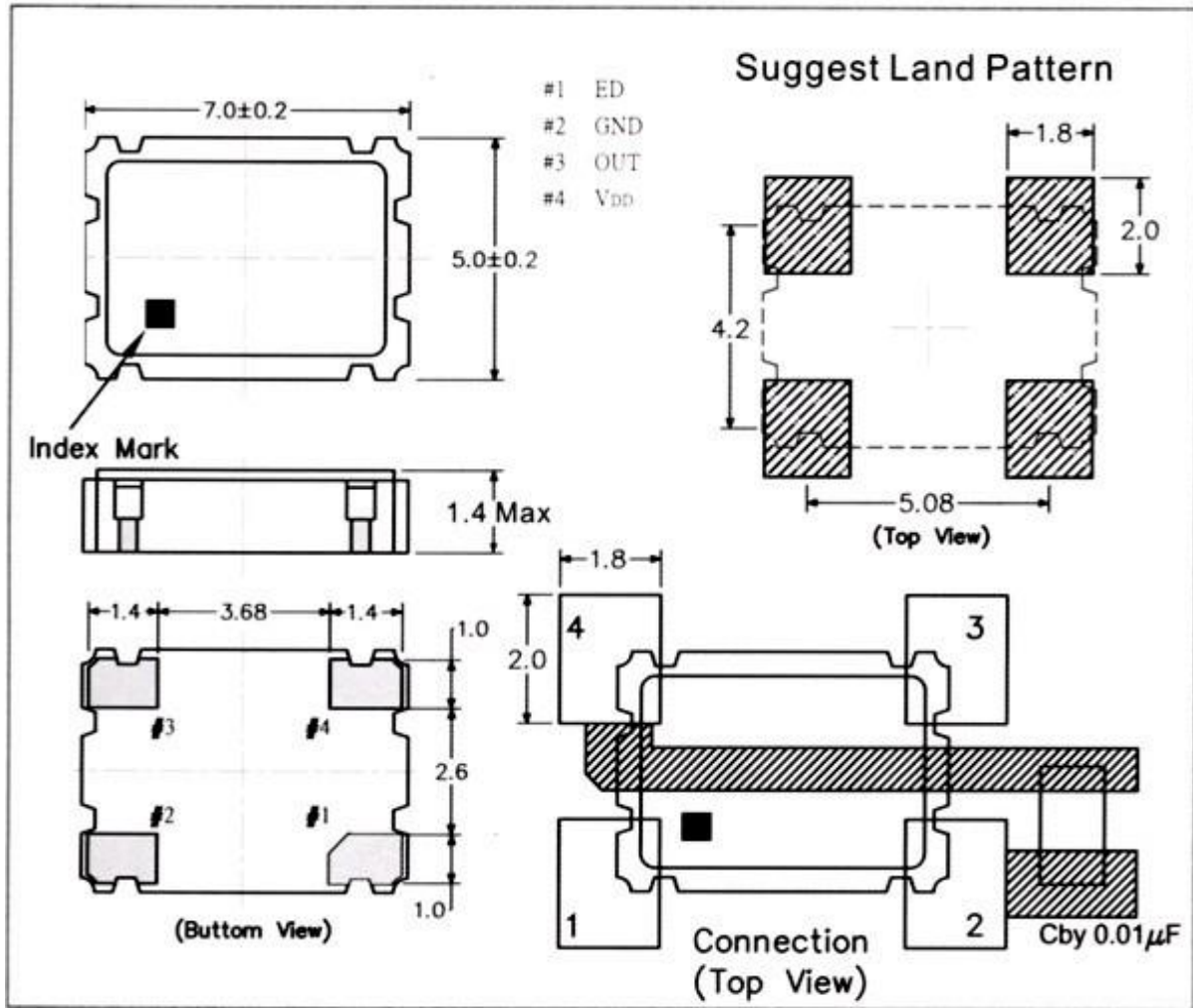

Tri-state: PIN 1 connected to Vdd or floating, the product is working properly; connected to GND, stops working

■ 输出波形图

