

## OSC7050 22.000MHZ

### Features

- CMOS compatible logic levels.
- Pin-compatible with standard 7.0\*5\*1.4mm. packages
- Low power standby mode.
- High precision characteristic covering up to high frequency range.
- Low jitter and tight stability with fundamental or overtone Design.
- Pb-free and RoHS/Green compliant.
- Output Tri-state function.
- Embossed taping specification.
- Reflow soldering.

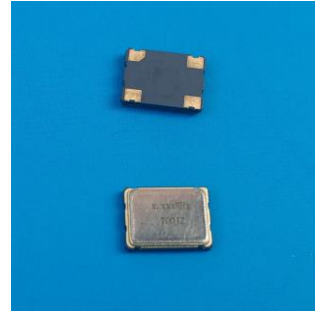

### APPLICATIONS

● Ideally suited designed for discdrives ,NB, Networking, GPS/Navigation, BlusTooth, Ethernet, ADSL, VDSL, Fiber channel hand-held electronic products.

### Specifications 电气参数

| 项目Item                 | 技术Specifications   |
|------------------------|--|
| 频率范围Freq. Range        | 22.000MHZ  |
| 总频差Frequency Stability | $\pm 20\text{ppm T0} \pm 50\text{ppm}$   |
| 工作温度Operaing Temp      | $-20^{\circ}\text{C to } 70^{\circ}\text{C} / -40^{\circ}\text{C to } 85^{\circ}\text{C}$  |
| 储存温度Storage Temp       | $-40^{\circ}\text{C to } 85^{\circ}\text{C} / -55^{\circ}\text{C to } 125^{\circ}\text{C}$ |
| 输入电压Supply Voltage     | +5Vdc or 3.3V $\pm 10\%$ ※(see Notes)  |
| 占空比 Symmetry           | 40/60 Standard   |
| 输出Output Load          | 15PF HCMOS   |
| 消耗电流                   | Current Consumption 15pf only) (5.0V)  |
|                        | Current Consumption 15pf only) (1.8V 2.5V 2.85V 3.3V)                                      |
|                        |  |
| 上升/下降时间Rise/Fall Time  | 5nS max  |

※Notes: The supply voltage 1.8V, 2.5V, 2.85V also can be made by customer.

### Test Circuit 测试电路图

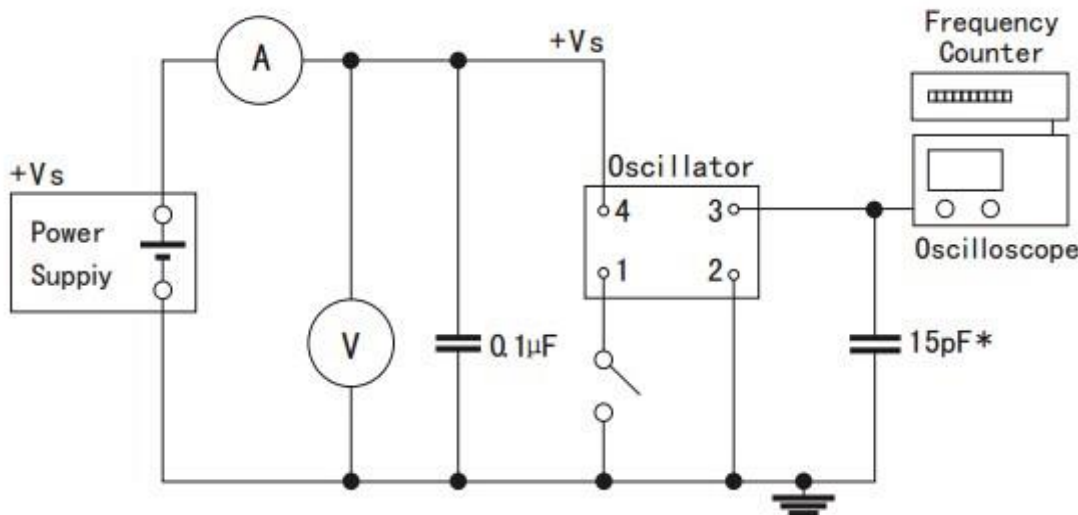

■ Dimensions 尺寸封装图

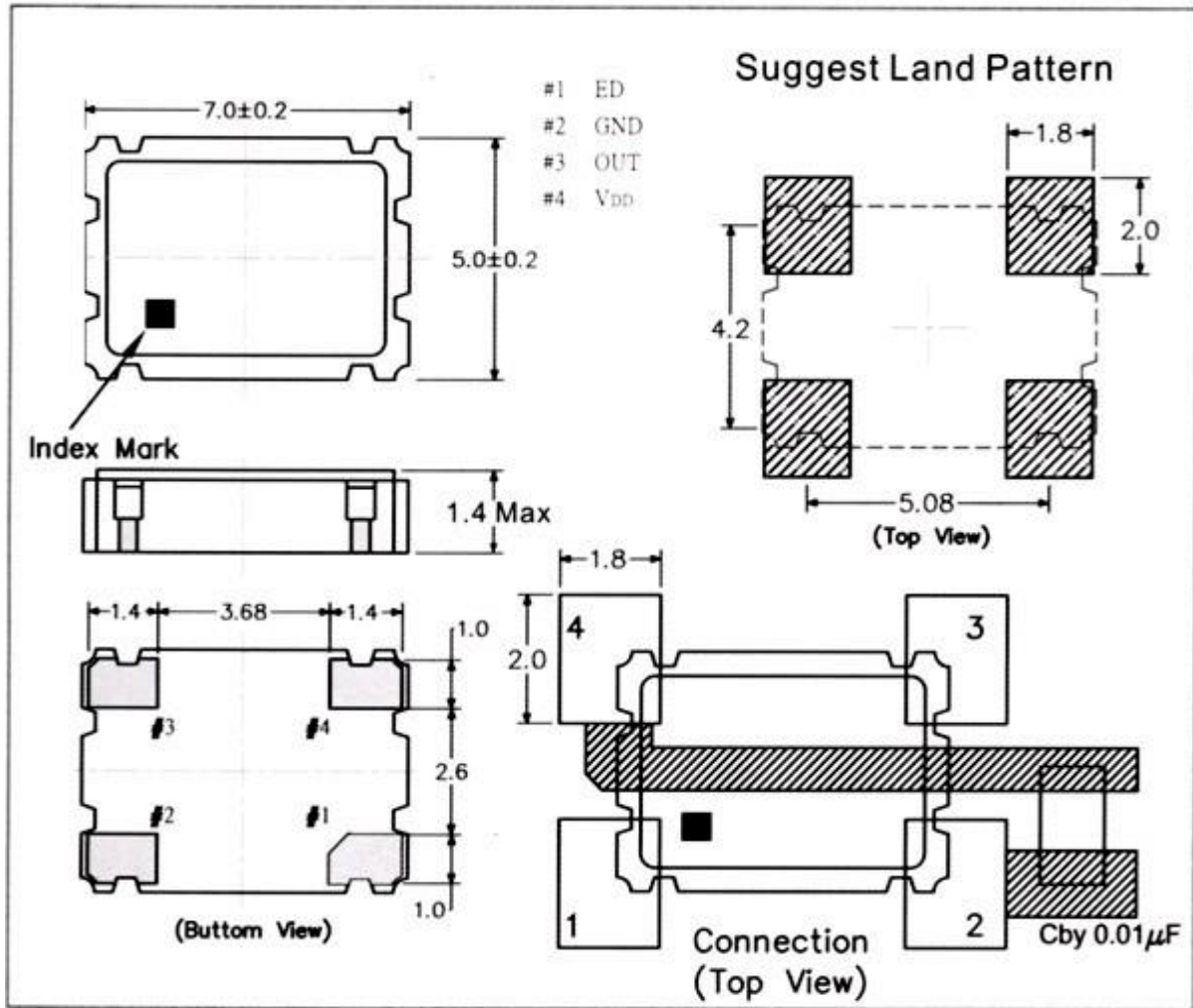

Tri-state: PIN 1 connected to Vdd or floating, the product is working properly; connected to GND, stops working

■ 输出波形图

