



无源直插晶振49S-11.2896MHZ

Features

- Resistance weld seal.
- A resistance weld completely sealed type.
- The tight frequency stability.
- Low cost.
- Versatile.
- Pb-free and ROHS/Green compliant.



Applications

- Ideally suited designed for Set-Top Box/Multimedia, modems, clock/vcxo multiplier, network adapter cards and remote control devices.

Specifications

项目Item	技术Specifications
型号Holder Type	49S-11.2896MHZ
频率范围 Frequency Range	11.2896MHZ
调整频差Frequency Tolerance(ΔF)	$\pm 10\text{PPm}$ to $\pm 30\text{PPm}$ (at 25°C)
温度频差Frequency Drift	$\pm 10\text{PPm}$ to $\pm 30\text{PPm}$ ※(See Notes 2)
工作温度Operaing Temp	-20°C to 70°C/-40°C to 85°C
储存温度Storage Temp	-40°C to 85°C/-55°C to 125°C
老化能力 Aging (25°C)	$\pm 5\text{PPm/year}$ Maximum
静电容Shunt Capacitance(C0)	7pF maximum
激励功率Drive Level	100 μW Typical
绝缘阻抗Insulaton Resistance(Rs)	500 Megaohms Minimum at D, C100V
负载电容Load Capacitance (CL)	Suggested by customer

※Notes1;For 2.5mm height, lowest frequency is 10 MHZ.

For 2.8mm height, lowest, frequency is 6 MHZ

※Notes2; ± 10 , ± 20 , $\pm 30\text{ppm}$ (-20°C to 70°C)

± 20 , ± 30 , $\pm 50\text{ppm}$ (-40°C to 85°C) or depends on customer

Equivalent Series Resistance and Mode of Operation

Frequency (MHz)	Mode	ESR (Ω) Max	Frequency (MHz)	Mode	ESR (Ω) Max
3.2~3.579	Fund.	250	10.0~14.0	Fund.	50
3.579~4.0	Fund.	150	14.0~20.0	Fund.	40
4.0~5.0	Fund.	120	20.0~48	Fund.	30/40(BT cut)
5.0~6.0	Fund.	100	35~40	3th I. T.	100
6.0~7.0	Fund.	80	40~100	3th I. T.	80
7.0~10.0	Fund.	60			

Dimensions

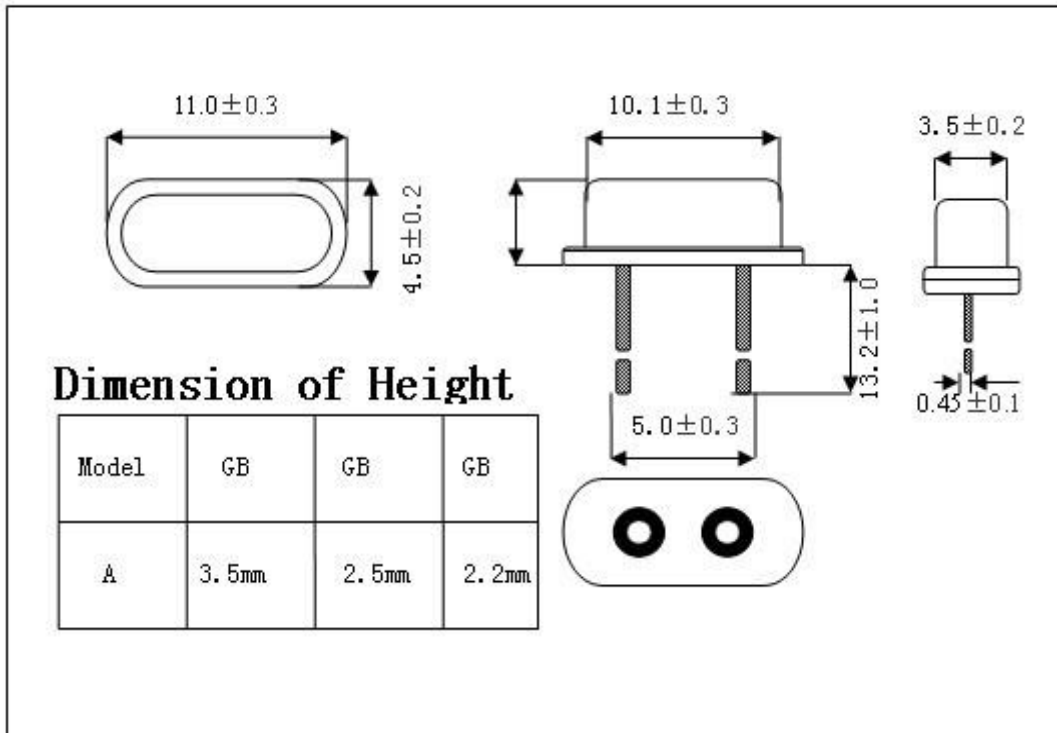

Reflow Condition

